

De Faugères

MANUEL D'ASSEMBLAGE ASSEMBLY INSTRUCTIONS

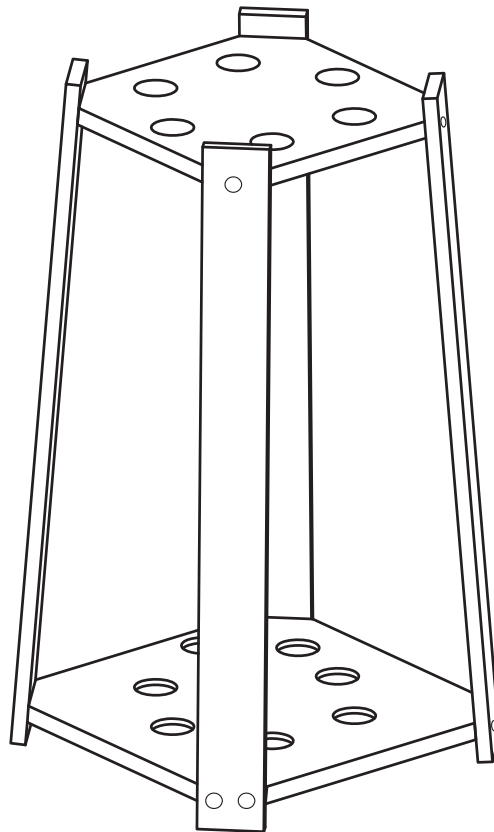

PORTE-QUEUES 8 EMPLACEMENTS - MODÈLE OCTA 8 HOLES CUE RACK - OCTA EDITION



De Faugères





Copyright De Faugères. All Rights Reserved.
JG FASHION SARL | 450 ROUTE DE BORDENOUD | 38110 DOLOMIEU | FRANCE
www.defaugeres.eu

De Faugères est une marque enregistrée par JG Fashion SARL.
Produits importés par JG Fashion SARL. Fabriqué en Chine.
De Faugères is registered by JG Fashion SARL. Imported by JG Fashion SARL. Made in China.

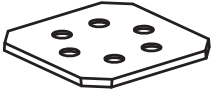

CONTENU

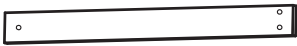
CONTENT

<p>#1</p>  <p>Socle principal - 1pc Main stand - 1pc</p>	<p>#2</p>  <p>Partie haute - 1pc Upper part - 1pc</p>	<p>#3</p>  <p>Traverse - 4pcs Board - 4pcs</p>	<p>#4</p>  <p>Vis - 12pcs Screw - 12pcs</p>
<p>#5</p>  <p>Clé six pans - 1pc Hex wrench - 1pc</p>			

ASSEMBLAGE ASSEMBLY

ETAPE 1 / STEP 1

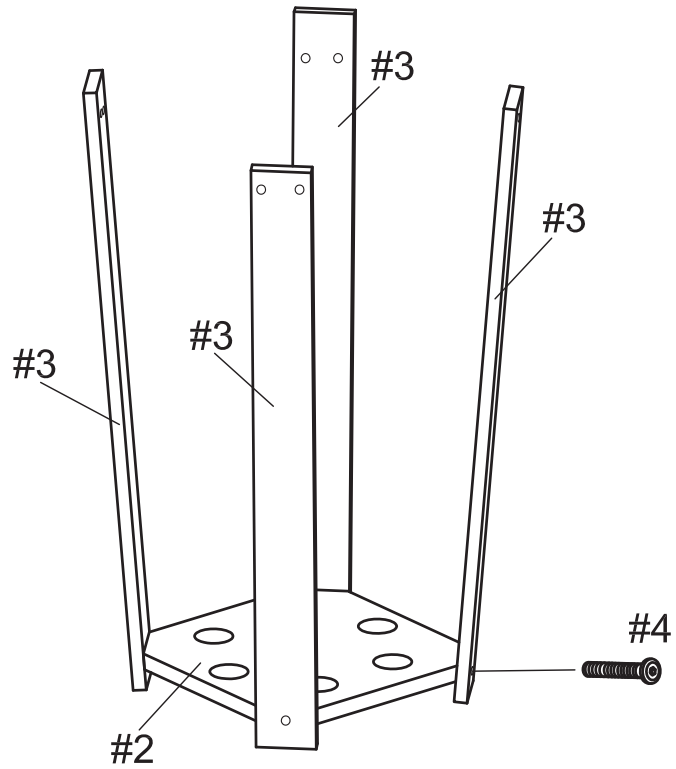

ETAPE 2 / STEP 2

